

Model 220s Specifications:

Construction

Plastic Housing (ASA Resin)

**Fully Up& Down 135° Tilting /
Left & Right 360° Unlimited Rotation (Patented)**

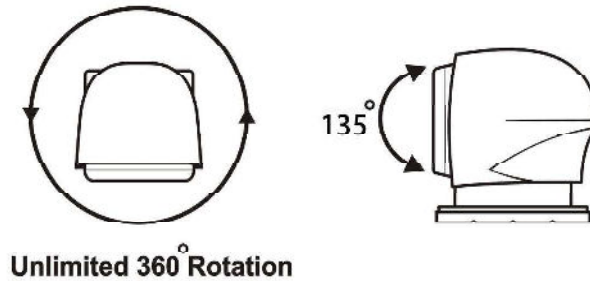

Shape : Circular

Color : White/ Black housing



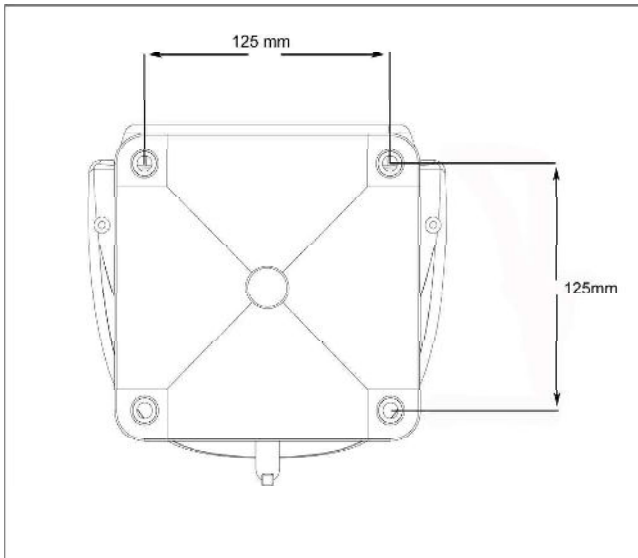

Weather Resistance/Anti-UV/Anti-Corrosion

**Mount type : Permanent Mount Base
(Optional magnetic mount shoe available)**

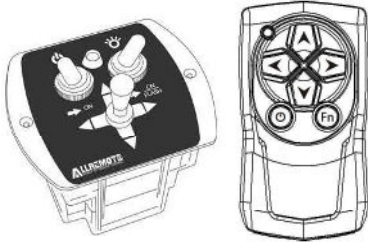
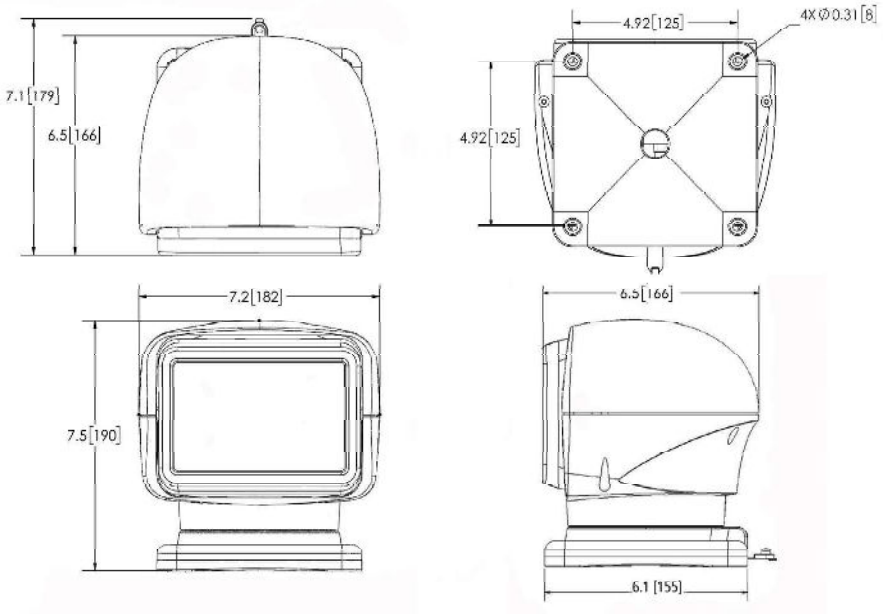

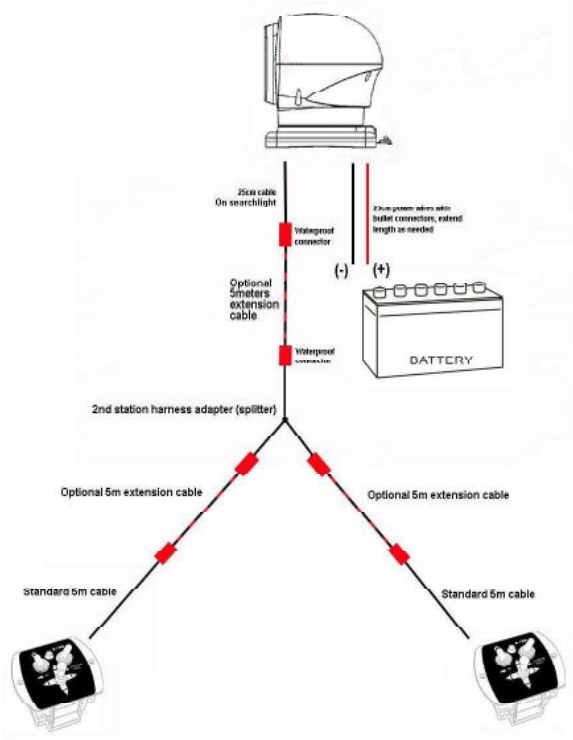
Weight: 2.1kgs

<p>Control Device</p>	 <p>Wired & Wireless Dual Toggle Control Panel (Fast/slow speed switch)</p> 
<p>Light</p>	<p>OSRAM High Power LED x 10PCS Watts: 50W Current Consumption : 13.5V 5A(MAX) / 28V 3A(MAX) Color Temperature: 5700~6000K Beam Pattern : Spot Luminous Intensity: 460,000 Candela LED module IP 68 Compliant Aluminum Housing As Heat Sink Hardened Polycarbonate Lens</p>
<p>Dimension</p>	<p>Unit: inch [mm]</p> 

	 <p>Standard 5m cable (LINE-DIPS-0249)</p> <p>2nd station harness adapter (splitter) (LINE-DIPS-0336)</p> <p>Optional 5m extension cable (LINE-DIPS-0253) *Optional 5m extension cable can be connected many together as needed</p>
<p>Power</p>	<p>   &   Multi-voltage </p>
<p>Certification</p>	<p>CE / FCC /R10</p>
<p>Packing</p>	<p>4pcs/Carton Measurement: 46x28x44cm/0.057CBM or2cuft</p>